



# **IT WASH**

## **G5 PROJECT**

User Manual  
Use and Maintenance



**Please read the instructions carefully**

before handling, installing and using your home appliance so as to prevent any damage to yourself and to your washing machine

[WWW.SANGIORGIOELETTRODOMESTICI.IT](http://WWW.SANGIORGIOELETTRODOMESTICI.IT)  
[INFO@SANGIORGIOELETTRODOMESTICI.IT](mailto:INFO@SANGIORGIOELETTRODOMESTICI.IT)



# IMPORTANT OPERATIONAL INSTRUCTIONS



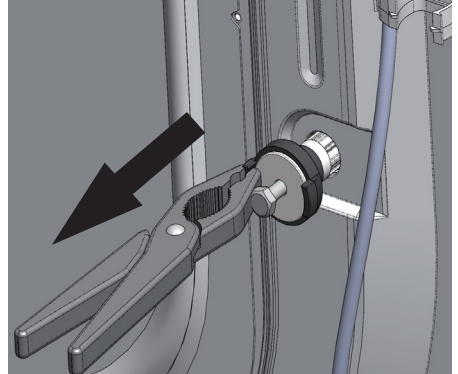
Carefully read the instruction booklet

## PHASE 1: REMOVAL OF FIXING SCREWS

**Fig.1**

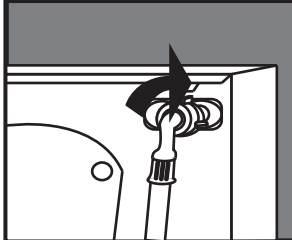
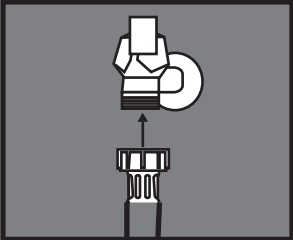


**Fig.2**



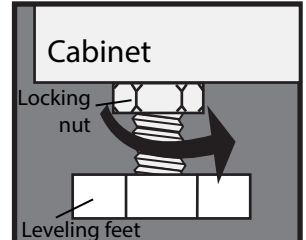
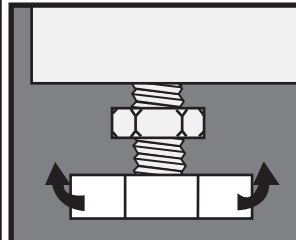
Remove the screws include spacers by pulling outward (Figure 2.)

## PHASE 2: WATER CONNECTION



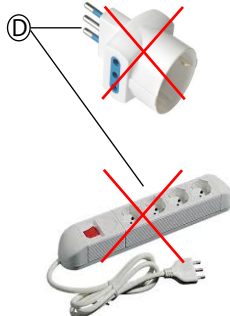
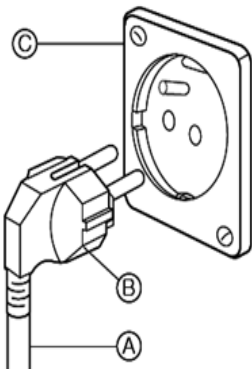
Check for leaks after connection to the water supply.

## PHASE 3: PLACEMENT



Place the washing machine on a non-elevated level or plain of the floor. After offsetting any unevenness by the regulating the leveling feet, it should be locked by the locking nut.

## PHASE 4: ELECTRICAL SPECIFICATIONS THIS MACHINE REQUIRES GROUNDING (EARTHING)



**Electric shock hazard: the lack of these warnings can be harmful to health.**

For your personal safety, this washing machine must be connected to earth device.

If earthing device not installed, it must be installed by a qualified technician before starting the machine.

This washing machine is equipped with a power cord (A) and with a plug (B).

To minimize the risk of electric shock, the cable must be plugged into a wall socket (C) that accepts the plug (B).

If the wall socket is not available it is a personal responsibility and the duty of the client to have it installed by a qualified electrician.

Do not change/modify the power cord and do not use adapters or extension cords (D).

*Dear Customer,*

*First of all we would like to thank you for choosing us and purchasing an original Italian product.*

*This product has been fully manufactured in ITALY with the best materials, in accordance to RoHs and Reach regulations with special attention to human health and environment.*

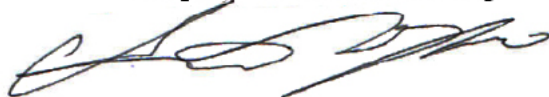
*Key issues like quality and safety are supported by strict controls on our products, which have been certified according to inter-national regulations such as EN 60456:2016, EN 62233:2010, EN 61770:2009, EN ISO3741:2010, EN 60456:2016, EN 60335:2014, EN 61770:2009, EN ISO 3741:2010, EN 60704:2012, EN 6100:2014, EN 55019:2015 through certifications issued by VDE and IMQ, the latter being certifying bodies of excellence. This manual contains instructions for the use, maintenance and warranty.*

*Before using the machine for the first time, please carefully read this user manual and the warranty certificate placed at the end of this manual. There you can find important instructions for the safety, use and maintenance of the washing machine. This is to protect yourself from any possible injury and to avoid damages to the appliance.*

*Always keep your purchase receipt with you which will be useful to activate the warranty. To be valid for warranty, the receipt must show the date of purchase, type of the appliance and model.*

**SANGIORGIO**

*Responsabile Marketing*



**EN**

### DISPOSING OF PACKAGING

The packaging has the purpose of protecting the good from any possible damage which could occur during transport operations. All materials used for the packaging are reusable and selected according to eco friendly standards so that they can be easily recycled in order to be reused into the production process. On the one hand, this mechanism allows to reduce waste and on the other, it makes possible a more rational use of non-renewable resources.

### WASTE ELECTRIC AND ELECTRONIC EQUIPMENT (RAEE)

In accordance with Directive on waste electric and electronic equipment, the symbol of the crossed-out wheeled bin means that the end-of-life product must be disposed separately from domestic household waste.



The user should, therefore, take the product to an appropriate recycling centre for waste electrical and electronic equipment or give it back to the retailer at the time of purchasing new similar equipment, on a one for one basis.

The proper separate disposal of the decommissioned product and its eco-compatible recycling, treatment and scrapping contribute to avoid possible negative effects on the environment and human health, and encourage the recycling of the materials comprising the product.

The manufacturer has always been focused on developing products and technologies that make as little impact on the environment as possible and has been continuously engaged

in high R&D investments which are required in the fields of ecology.

For the waste management and disposal of the household appliances, the manufacturer registered with the consortium ERP Italia.



The illegal disposal of the product by the user leads to the application of administrative sanctions in accordance with current laws and regulations.

# TABLE OF CONTENT

<b>Table of content</b> .....	<b>5</b>	<b>Product data sheet</b> .....	<b>18</b>
<b>Safety instructions and warnings</b> .....	<b>6</b>	<b>Laundry symbols for washing machine</b> .....	<b>21</b>
Intended use.....	6	<b>Instructions and warnings</b> .....	<b>22</b>
Definitions of children.....	7	Washing instruction.....	22
Electrical safety.....	7	Laundry selection.....	22
Water safety.....	8	Loading laundry.....	23
Positioning.....	8	Detergent dosage.....	23
Correct use.....	8	Liquid detergent bulkhead insert.....	23
<b>Installation</b> .....	<b>10</b>	Starting washing.....	23
General information.....	10	Starting washing cycle.....	24
Fixing screws removal.....	10	Pause washing.....	24
Positioning of appliance.....	10	Detergent drawer.....	24
Installation under worktop.....	11	<b>Maintenance</b> .....	<b>25</b>
Water supply inlet hose.....	11	Cabinet.....	25
Water drainage.....	12	Detergent drawer.....	25
Electrical connection.....	12	Drain pump filter cleaning.....	25
<b>Control panel</b> .....	<b>14</b>	Emptying procedure.....	26
<b>Command description</b> .....	<b>15</b>	Cleaning of electro-valvle and water supply hose filters.....	26
Programme knob.....	15	Water loading test.....	26
Spin regulation.....	15	<b>Possible remedies</b> .....	<b>28</b>
Options.....	15	<b>After sales service</b> .....	<b>31</b>
Start/Pause.....	15	<b>Warranty certificate</b> .....	<b>32</b>
Washing phases.....	15		
Child lock.....	15		
<b>Programme, duration and options</b> .....	<b>16</b>		

EN

# SAFETY INSTRUCTIONS AND WARNINGS

This washing machine complies with current safety norms and regulations. If improperly used, it can provoke damage to people and/or goods around you. Before using the washing machine for the first time, please read this user guide carefully. It contains important instructions for the safety, use and maintenance of the washing machine. This will prevent any possible danger for yourself and damage to the appliance. Please keep the user guide with you and give it to other users, if necessary.

## INTENDED USE

Please, note that this washing machine is only for domestic use and only to wash clothes which have been indicated by the manufacturer as suitable for washing in water on the label. Any other use can turn dangerous. The manufacturer cannot be held liable for damages caused by an improper and/or incorrect use of the household appliance.

In other cases, the washing machine must not exceed one

washing cycle a day. Some example are:

- staff kitchen areas in shops, offices and other working environments;
- farm houses;
- by clients in hotels, motels and other residential type environments;
- bed and breakfast type environments;
- areas for communal use in blocks of flats or in launderettes.

## USE BY CHILDREN OR VERY VULNERABLE PEOPLE

This appliance can be used by children of at least 8 years and by people with limited physical, sensorial or mental ability or with no required knowledge, as long as they are kept under surveillance or they have been instructed about safety norms to apply for the use of the appliance and possible risks. Children shall not play with the appliance. Cleaning and maintenance operations must not be made by children without supervision.

Children under the age of 3 must be supervised while the appliance is in function.

## **CAUTION!**

**When washing at high temperature, be aware that the door glass could become very hot (about 90°C). Prevent children from touching it.**

## **DEFINITIONS OF CHILDREN**

### *Very young children*

Up to 3 years old.

### *Young children*

Between 3 and 8 years old.

### *Older children*

Between 8 and 14 years old.

### *Vulnerable people*

People with limited physical, sensorial or mental ability (i.e. partially disabled, adults with limited physical and mental ability), or without the required knowledge (i.e. older children).

## **ELECTRICAL SAFETY**

Before plugging the washing machine into the electrical socket,

be sure that the power supply is in line with the data (power, frequency) indicated in the technical data label. If any doubt, consult a qualified electrician.

**The electrical safety of the appliance can only be guaranteed when it is connected to an electrical system which is compliant with all legal standards and equipped with a separate magneto thermal differential switch (circuit breaker) and earthed. Do not use extension leads or adapters.**

This is a key safety requirement. Verify this condition and in case of any doubt, it is advised to call a qualified electrician who shall check the electrical system.

**N.B. The manufacturer should not be held liable for damages resulting from an electrical system compliant with all legal standards.**

The appliance can only be repaired by an Authorized Technician. If it is not the case, the manufacturer cannot be held liable for any

possible damage that could arise. If not properly repaired, the user may be exposed to serious danger, for which the manufacturer cannot be held liable.

If the power supply cable is damaged, it must be replaced by an authorized technician in order to avoid any possible danger.

In the event of faults, prolonged absences or to clean the appliance, disconnect it from the electrical mains.

The appliance is considered to be disconnected from the mains when:

- The power cable is unplugged from the socket.
- The central switch has been turned off.

## **WATER SAFETY**

To connect the appliance to the water supply, use only new hoses. Do not use old hoses.

Be sure that during the washing cycle, the detergent drawer is always closed and turn off the water tap at the end of each washing cycle.

It is not possible to make modifications to the appliance

without a prior authorization by the manufacturer. Before connecting the draining hose to the sink, make sure that the water is easily drained.

Secure the draining hose so that it cannot move because the strong flow of water could push it out of the sink.

## **POSITIONING**

The appliance must not be installed on roofs, balconies, under canopies or in places where it may be exposed to atmospheric agents.

## **CORRECT USE**

Before using the appliance for the first time, remove the transport securing screws from the rear (see installation chapter).

If those screws are not removed, it will damage the appliance or adjacent furniture or other appliances during the spinning. Make sure garments are not washed together with foreign objects (i.e. nails, needles, coins, paper clips). These foreign objects may damage the appliance (i.e. the drum or the tub) and, in turn,



the damaged parts may damage the garments. Garments that have been pre-treated with solvents or products containing solvents, have to be carefully rinsed with clean water before washing in the appliance. Never use detergents with solvents (i.e. petrol, trichloroethylene). These products may damage some components of the appliance and produce toxic vapors which could potentially provoke fires, blasts or damaged surfaces.

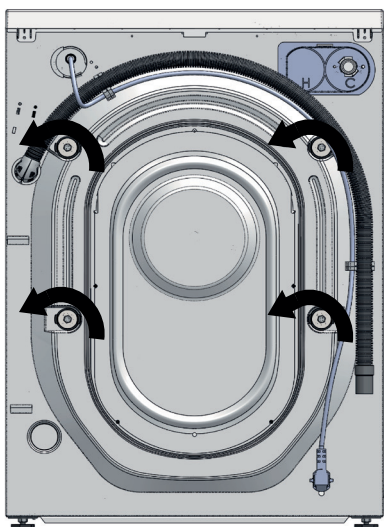
**N.B. The manufacturer cannot be held liable for damages caused as a result of not following the instructions in the manual.**

# INSTALLATION

## GENERAL INFORMATION

The assembled group of the appliance is secured by 4 fixing screws (which protect it during handling and transport operations), figure 1.

Figure 1



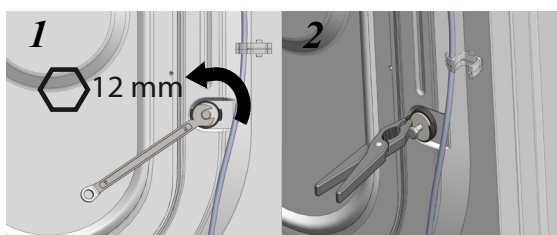
## FIXING SCREWS REMOVAL

**Before using the appliance, it is necessary to remove the fixing screws by turning counter clockwise.**

N.B. If the fixing screws are not removed, this will cause strong vibrations and irregular movements during the washing cycle with subsequent damages.

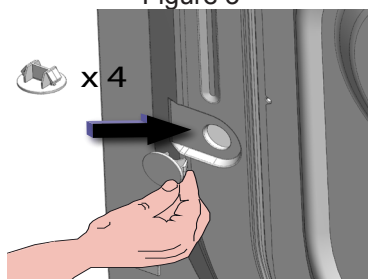
**Once unscrewed, pull them out with spacer bushes as shown in figure 2.**

Figure 2



**Seal the holes with the appropriate caps provided as shown in figure 3.**

Figure 3



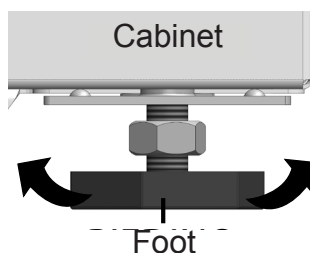
## POSITIONING OF APPLIANCE

In order to avoid damages or malfunctions, the appliance must not be installed on roofs, balconies, under canopies or in places where it may be exposed to atmospheric agents.

Make sure the electrical cable and hoses (water inlet and drain hoses) on the rear of the appliance are not pressed.

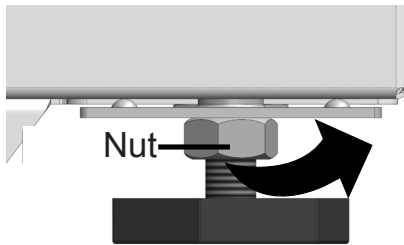
To ensure the stability of the appliance, avoiding strong vibrations during washing and spinning cycles, it is necessary to put the appliance on a **levelled, smooth, dry, solid surface not raised from the floor level**. In order to balance any difference in levels of the floor, it is possible to intervene on the feet modifying the height by screwing and unscrewing in accordance with the necessities as shown in figure 4.

Figure 4



After regulating the feet, since vibration may modify its level, it is advisable to tighten the docking nut on the feet until it is blocked as shown by the figure below.

Figure 5

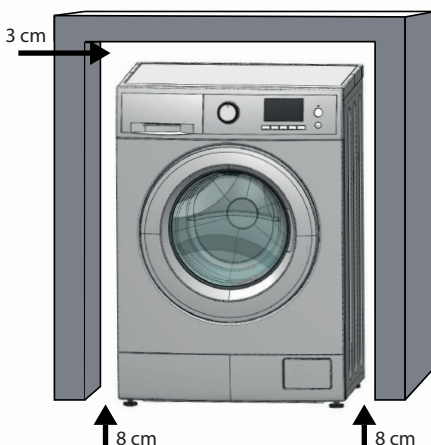


It is recommended to avoid putting cardboard, pieces of wood or similar material upon or around the appliance since it may obstruct the air flow.

### INSTALLATION UNDER WORKTOP

It is possible to position the appliance under a worktop only if there is place of minimum 3cm on the upper side, 8cm on the sides and 8cm on the back side. An example of a typical installation is represented in figure 6. The top table of the appliance (TOP) cannot be removed for electric and mechanical safety reasons.

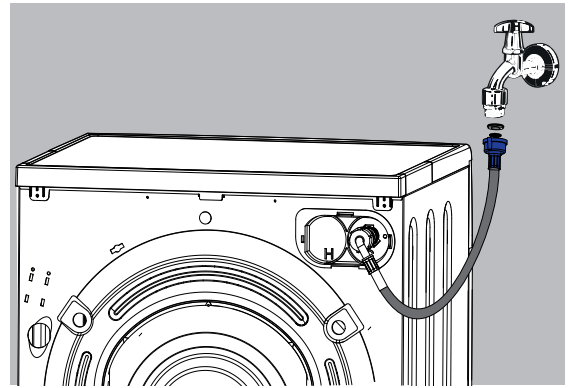
Figure 6



### WATER SUPPLY INLET HOSE

The water supply inlet hose has to be connected to a cold water tap with threaded hole of 3/4" and to the appliance. Only use the hose supplied with the appliance and make sure that the rubber gaskets are properly placed on the ends of the hose.

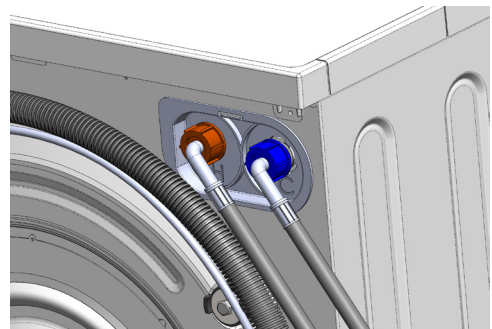
Figure 7



EN

If the water supply system is new or it has not been used for a long time, before connecting the hose it is necessary to let the water run until it is clear. Figure 8 shows the connection to hot water. This option is available only on demand.

Figure 8



Be sure the hot water temperature does not exceed 55°C in order to avoid damages to the clothing and to the washing machine. Use only the water supply inlet hose which is supplied with the appliance.

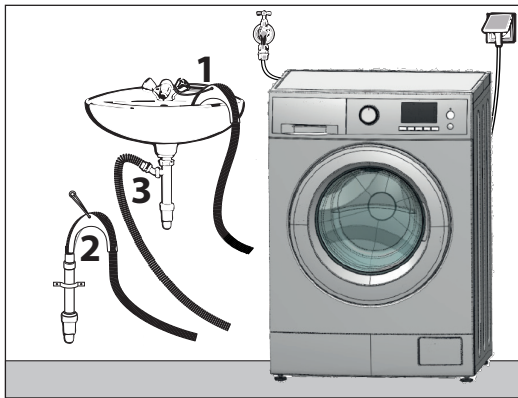
## WATER DRAINAGE

The water drain hose can be positioned in three different ways (Figure 9):

- 1. On the edge of a sink, using a U-hook plastic (NOT SUPPLIED)**  
Make sure the hose is well fixed on the sink.
- 2. Into a drainage line placed at a minimum height of 60cm and not exceeding 90cm.**
- 3. Direct drain into the siphon of the sink.**  
It is advisable to use a hose clamp (NOT INCLUDED)

Example of installation

Figure 9



**N.B. It is not advisable to use hose extensions for the water drainage hose.**

## BEFORE USE

**Before using the washing machine for the first time, it is necessary to do a washing cycle (self-clean programme, where present or cotton programme set at 90 °C) with detergent and without laundry.**

## ELECTRICAL CONNECTION

The appliance is supplied with a power cable and a schuko plug for the connection to the ~ **230V 50Hz** AC grid . Make sure the schuko plug is always accessible so that washing machine can be disconnected from the mains if necessary. The electrical system must meet the provisions VDE 0100. The maximum consumption of the washing machine is **10 Ampere**. It is strongly recommended never to connect the appliance using extension cables, multiple sockets or similar devices in order to avoid overheating and a potential fire hazard. The manufacturer accepts no liability for damages resulting from lack or interruption of the protective earth conductor. With the purpose of increasing the safety level, VDE institute, by Directive DIN VDE 0100 part 739, recommends to equip the appliance with an automatic differential switch (circuit breaker) with trip off current of 30mA (DIN VDE 0664).

If an automatic differential switch is used, make sure it is of type A, in accordance with DIN VDE 0664 and sensitive to pulsating currents.

The identification plate provides information about the nominal power consumption and its appropriate protection. Please compare these data with the data of the electrical mains.

## THIS APPLIANCE REQUIRES AN EARTH WIRING.

For individual personal safety and of the environment, this appliance must be connected to the mains with an earthing which provides a direct path to the ground, correctly verified and in compliance with current laws and regulations. Its installation must be equipped with a magneto thermal differential switch (circuit breaker).

This appliance is supplied with a type (A) power cord and a type (B) plug.

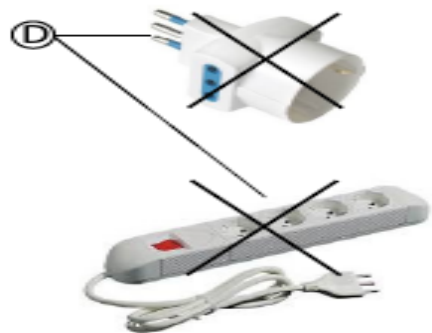
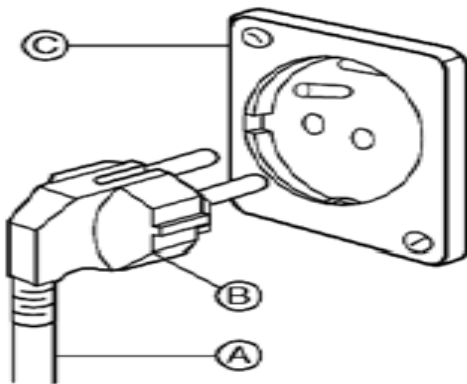
In order to avoid risks of electrical shocks/fires, the cable must be connected to a wall socket (C) suitable for the type of plug (B).

Do not modify the connection cable nor use adaptors or extension leads (D).

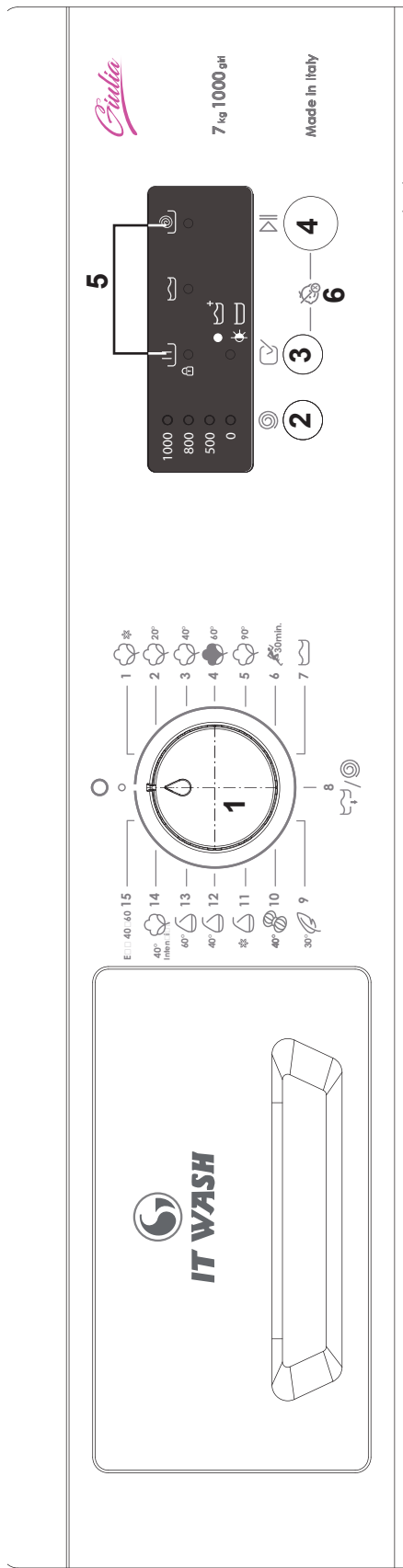
If the wall socket is not available, it is the customer's responsibility and obligation to install it by a qualified electrician.

Do not change/modify the electrical power cord and do not use adaptors or extension leads (D)

EN



# G5 CONTROL PANEL










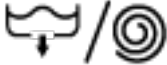



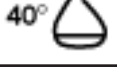
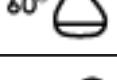
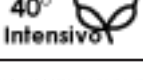
**1 - Programme knob**  
**2 - Spin regulation**

**3 - Options**  
**4 - Start/Pause**

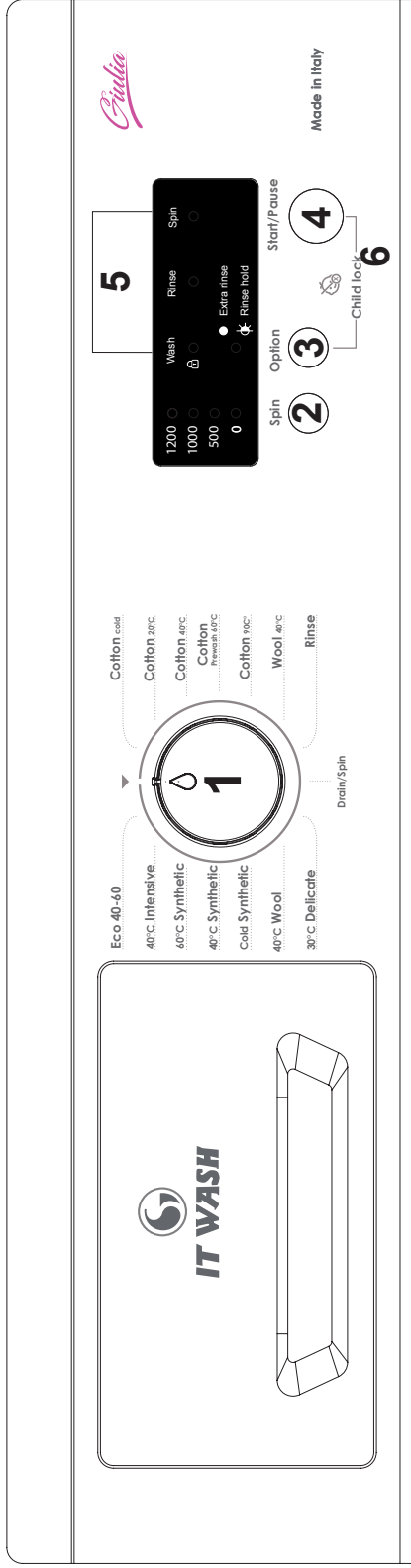
**5 - Wash phases**  
**6 - Child lock**

# TABLE OF WASH PROGRAMMES

EN

NUMERO PROGRAMMA	ICONA	DESCRIZIONE
1		Cotton cold
2		Cotton at 20°C
3		Cotton at 40°C
4		Cotton at 60°C + Prewash
5		Cotton at 90°C
6		Rapid
7		Rinse
8		Drain and spin
9		Delicate
10		Wool at 40°C
11		Synthetic cold
12		Synthetic at 40°C
13		Synthetic at 60°C
14		Cotton intensive at 40°C
15	<b>Eco 40-60</b>	Eco 40-60°C

# G5 CONTROL PANEL



- 1 - Programme knob
- 2 - Spin regulation

- 3 - Options
- 4 - Start/Pause

- 5 - Wash phases
- 6 - Child lock



# COMMAND DESCRIPTION

## 1. Programme knob

The programme knob is used to select the desired programme and to turn off the machine. It can be rotated clockwise and counterclockwise for easy and fast selection of programmes. The programmes have preset temperature.

## 2. Spin regulation

This button allows for the reduction or exclusion of spin. When one of the 15 available programmes is selected, the preset value lights up. To change this value press repeatedly the spin key until the desired value is reached. The corresponding LED lamp will be illuminated to identify the selected spin value.

## 3. Options

This button allows for the selection of the available options of the selected washing programme. The options available are two - rinse hold and extra-rinse. The selection is signalled by the illumination of a LED. Depending on the selection, the LED may be:

- fixed when extra-rinse is selected
- flashing when rinse hold is selected;
- off when no option is selected.

## 4. Start/Pause

This key allows for the starting or pausing the washing programme momentarily.

## 5. Washing phases

During washing operations, a LED would indicate the washing status.

The possible status are three:

- washing;
- rinsing;
- spinning.

## 6. Child lock

The function activates the lock of all buttons on the control panel. The activation is achieved by pressing buttons 3 and 4 simultaneously for 15 seconds. Its activation is marked by the flashing of the spin LED. To deactivate the function, press buttons 3 and 4 simultaneously for 10 seconds. Upon the deactivation spin LED will stop flashing.

EN

# PROGRAMMES, DURATION AND OPTIONS

The "Eco 40-60" programme is able to clean normally soiled cotton laundry declared to be washable at 40°C or 60°C, together in the same cycle. This programme is used to assess the compliance with the EU eco-design legislation. It is the most efficient programme in terms of energy consumption. The programme generally performs at lower temperatures and longer time.

All available commercial powdered and liquid detergent a for washing machine are suitable of use in the washer. For the recommended washing temperatures and programmes, refer to the detergent manufacturers' prescription.

Noise and remaining moisture are contents are influenced by the spinning speed. The higher the spinning speed in the spinning phase, the higher the noise and the lower the remaining moisture content.

Information on each model can be capture and viewed in the weblink using the QR code. Access is possible on with an QR scanner.

Programme Temperature allowed Spin speed Type of laundry	Loading capacity indicated on control panel	CMAXIMUM laundry load (kg)	MINIMUM laundry load (kg)	Programme durations (*)	Wash options
<b>1 - Cotton cold</b> Ambient temperature; 0 - Max spin; Cotton or linen bedsheets, pillowcases and tablecloths .	5 kg	5	2.5	1h 50 min.	Extra rinse. Rinse hold.
	6 kg	6	3		
	7 kg	7	3.5	2h 00 min.	
	8 kg	8	4		
<b>2 - Cotton 20°C</b> Temperature at 20°C; 0 - Max spin; Cotton or linen bedsheets, pillowcases and tablecloths.	5 kg	5	2.5	2h 00 min.	Extra rinse. Rinse hold.
	6 kg	6	3	2h 10 min.	
	7 kg	7	3.5		
	8 kg	8	4		
<b>3 - Cotton 40°C</b> Temperature at 40°C; 0 - Max spin; Cotton or linen bedsheets, pillowcases and tablecloths.	5 kg	5	2.5	2h 10 min.	Extra rinse. Rinse hold.
	6 kg	6	3	2h 20 min.	
	7 kg	7	3.5		
	8 kg	8	4		
<b>4 - Cotton Prewash 60°C</b> Temperature at 60°C; 0 - Max spin; Cotton or linen bedsheets, pillowcases and tablecloths.	5 kg	5	2.5	2h 40 min.	Extra rinse. Rinse hold.
	6 kg	6	3	2h 50 min.	
	7 kg	7	3.5		
	8 kg	8	4		
<b>5 - Cotton 90°C</b> Temperature at 90°C; 0 - Max spin; Cotton or linen bedsheets, pillowcases and tablecloths.	5 kg	5	2.5	2h 30 min.	Extra rinse. Rinse hold.
	6 kg	6	3	2h 40 min.	
	7 kg	7	3.5		
	8 kg	8	4		
<b>6 - Rapid 30°C</b> Temperature at 30°C; 0 - Max spin. Cotton or Synthetic fabric.	5 kg	2.5	1.5	40 min.	Rinse hold.
	6 kg	3	1.5	40 min.	
	7 kg	3.5	2		
	8 kg	4	2		
<b>7 - Rinse</b> Ambient temperature; 0 - Max spin; Adaptable to all fabrics.	5 kg	5	2.5	25 min.	Extra rinse. Rinse hold.
	6 kg	6	3	13 min.	
	7 kg	7	3.5		
	8 kg	8	4		
<b>8 - Drain/Spin</b> 0 - Max spin; Adaptable to all fabrics.	5 kg	5	2.5	13 min.	-
	6 kg	6	3		
	7 kg	7	3.5		
	8 kg	8	4		
<b>9 - Delicate 30°C</b> Temperature at 30°C 0 - 600 rpm. Adaptable to all fabrics.	5 kg	0.5	-	1h 00 min.	Extra rinse. Rinse hold.
	6 kg	0.5	-	1h 05 min.	
	7 kg	1	-		
	8 kg	1.5	-		

Programme Temperature allowed Spin speed Type of laundry	Loading capacity indicated on control panel	C MAXIMUM laundry load (kg)	MINIMUM laundry load (kg)	Programme durations (*)	Wash options
<b>10 - Wool 40°C</b> Temperature a 40°C 0 - 1000 rpm. Wool and mixed wash- able wool.	5 kg	1	-	56 min.	Extra rinse. Rinse hold
	6 kg	1.5	-		
	7 kg	2	-	1h 05 min.	
	8 kg	2.5	-		
<b>11 - Synthetic cold</b> Ambient temperature; 0 - 800 rpm; Synthetic fabric (i.e. acrylic, polyester, microfiber).	5 kg	2.5	1.5	1h 25 min.	Extra rinse. Rinse hold
	6 kg	3	1.5	1h 35 min.	
	7 kg	3.5	2		
	8 kg	4	2		
<b>12 - Synthetic 40°C</b> Temperature a 40°C; 0 - 800 rpm; Synthetic fabric (i.e. acrylic, polyester, microfiber).	5 kg	2.5	1.5	1h 35 min.	Extra rinse. Rinse hold
	6 kg	3	1.5	1h 45 min.	
	7 kg	3.5	2		
	8 kg	4	2		
<b>13 - Synthetic 60°C</b> Temperature a 60°C; 0 - 800 rpm; Synthetic fabric (i.e. acrylic, polyester, microfiber).	5 kg	2.5	1.5	1h 55 min.	Extra rinse. Rinse hold
	6 kg	3	1.5	2h 05 min.	
	7 kg	3.5	2		
	8 kg	4	2		
<b>14 - Intensive 40°C</b> Temperature at 40°C; 0 - Spin; Cotton or linen bedsheets, pillowcases and tablecloths.	5 kg	5	2.5	2h 10 min.	Extra rinse. Rinse hold
	6 kg	6	3	2h 20 min.	
	7 kg	7	3.5		
	8 kg	8	4		
<b>15 - Eco 40-60</b> Temp. optimized; 0 - Spin; Cotton or linen bedsheets, pillowcases and tablecloths.	5 kg	5	2.5	2h 20 min.	Extra rinse. Rinse hold
	6 kg	6	3	2h 30 min.	
	7 kg	7	3.5		
	8 kg	8	4		

REFERENCE LAUNDRY LOAD WEIGHT FOR WASHING MACHINE	
Terry bathrobe	1200 g
Terry towels	900 g
Bedspreads	700 g
Pyjamas	500 g
Tablecloth	250 g
Pillowcases and Towels	200 g
Place mats and underwear	100 g

# PROGRAMMES TECHNICAL DATA

## UE 2019/2023 REGULATION

### Consumption values for 5kg washing machine

Programmes	Wash load	Duration (h:min)	Energy consump. (kWh/cycle)	Water consump. (l/cycle)	Maximum temperature for 5 min. (°C)	Residual humidity (%)
						1000 rpm
Cotton 20°C	5	1:43	0,20	35	18	63
Cotton 60°C + prewash	5	2:35	1,20	42	50	63
Cotton 90°C	5	2:40	1,65	50	69	63
Synthetics 60°C	3	1:40	0,70	31	48	75*
Express 30°C	3	0:35	0,25	23	26	64
Wool 40°C	1	1:18	0,53	55	37	59**

### Consumption values for 6kg washing machine

Programmes	Wash load	Duration (h:min)	Energy consump. (kWh/cycle)	Water consump. (l/cycle)	Maximum temperature for 5 min. (°C)	Residual humidity (%)		
						1000 rpm	1200 rpm	1400 rpm
Cotton 20°C	6	1:43	0,20	40	18	53	48	47
Cotton 60°C + prewash	6	2:35	1,23	48	50	53	48	47
Cotton 90°C	6	2:40	1,68	58	69	53	48	47
Synthetics 60°C	3	1:40	0,73	36	48	75*	75*	75*
Express 30°C	3	0:35	0,28	26	26	53	48	47
Wool 40°C	1,5	1:20	0,56	63	37	59**	59**	59**

### Consumption values for 7kg washing machine

Programmes	Wash load	Duration (h:min)	Energy consump. (kWh/cycle)	Water consump. (l/cycle)	Maximum temperature for 5 min. (°C)	Residual humidity (%)		
						1000 rpm	1200 rpm	1400 rpm
Cotton 20°C	7	1:45	0,20	46	18	60	47	46
Cotton 60°C + prewash	7	2:38	1,26	56	50	60	47	46
Cotton 90°C	7	2:40	1,71	66	69	60	47	46
Synthetics 60°C	3,5	1:40	0,76	41	48	75*	75*	75*
Express 30°C	3,5	0:35	0,31	30	26	51	48	47
Wool 40°C	2	1:20	0,59	73	37	59**	59**	59**

(\*) Residual humidity value at 800 rpm.

(\*\*) Residual humidity value at 600 rpm.

## Consumption values for 8kg washing machine

Programmes	Wash load	Duration (h:min)	Energy consump. (kWh/cycle)	Water consump. (l/cycle)	Maximum temperature for 5 min. (°c)	Residual humidity (%)	
						1200 rpm	1400 rpm
Cotton 20°C	8	1:45	0,22	42	18	48	47
Cotton 60°C + prewash	8	2:35	1,43	57	50	48	47
Cotton 90°C	8	2:45	2,15	62	68	48	47
Synthetics 60°C	4	1:45	0,97	53	50	75*	75*
Express 30°C	4	0:35	0,42	33	27	47	46
Wool 40°C	2,5	1:25	0,82	77	37	59**	59**

(\*) *Residual humidity value at 800 rpm.*

(\*\*) *Residual humidity value at 600 rpm.*

# PRODUCT DATA SHEET IN ACCORDANCE WITH EU DIRECTIVE 1061/2010

TYPE	Nominal capacity (kg)	Energy class	Energy consumption Eco 40-60 (kWh/cycle)	Water consumption Eco 4060 (l/cycle)	Maximum temperature of treated fabrics (C°)			Remaining moisture content (%)			Spin speed (rpm)			Class weight remaining moisture content
					a*	b*	c*	a*	b*	c*	a*	b*	c*	
G510X	5	C	0,498	30	34	38	38	56	56	63	1000	1000	1000	C
G610X	6	C	0,537	30	37	35	36	53	53	55	1000	1000	1000	C
G612X	6	C	0,537	30	37	35	36	48	46	51	1200	1200	1200	B
G614X	6	C	0,537	30	37	35	36	47	47	51	1300	1350	1350	B
G710X	7	D	0,653	37	39	36	36	60	51	56	1000	1000	1000	C
G712X	7	D	0,653	37	39	36	36	60	50	55	1200	1200	1200	C
G812X	8	D	0,710	42	45	40	38	48	47	51	1200	1200	1200	B
G814X	8	D	0,710	42	45	40	38	47	46	50	1350	1400	1400	B

**Legend:**

a\* -> Nominal capacity

b\* -> Half load

c\* -> Quarter load

The following data are the same for all washing machines.

Type of washing machine: Stand alone.

Electrical connection: Power 2200 Watt – Voltage 220/230 Volt – Maximum current 10 Ampere.

Inlet water pressure: Min. 0,05 Mpa – Max: 1 Mpa.

1. Energy class “A” indicates more efficiency, while energy class “G” indicates lower efficiency.
2. The annual energy consumption in kWh is based on 220 standard cotton washes cycles at 60°C of full, half and quarter load. The real consumption depends on how the washing machine is effectively used.
3. The annual water consumption in litre is based on 220 standard cotton washes cycles at 60°C of full, half and quarter load. The real consumption depends on how the washing machine is effectively used.
4. Spin efficiency “A” indicates less quantity of water left on laundry, while spin efficiency “G” indicates more quantity of water on laundry.
5. The programme Eco 40-60 at 60°C is the standard wash programme. This programme is used to wash cotton garments with a regular stain and it is the more efficient programme in terms of combined consumption of water and energy.

The distributed product complies with the most recent European regulations and directives:

Low Voltage Directive (LVD) 2014/35/EC

Electro-magnetic Compatibility (EMC) Laws and Directive 2014/30/EU

Eco design requirements for household washing machines Directive 2019/2023/EU

	Programme duration (hour:min)			Noise emission in spinning (db)	Class of noise emission	Power consumption (W)				Dimensions (cm)			Type of installation	Ions release during washing
	a*	b*	c*			Off (W)	Stand-by (W)	Stand-by in rete (W)	Delay start (W)	H	W	L		
	3:08	2:30	2:30	79	C	0,08	0,81	N/A	N/A	84	59,5	45,5	Stand alone	No
	3:13	2:44	2:41	79	C	0,08	0,81	N/A	N/A	84	59,5	52	Stand alone	No
	3:13	2:44	2:41	71	A	0,80	0,64	N/A	2,75	84	59,5	52	Stand alone	No
	3:13	2:44	2:41	79	C	0,09	0,35	N/A	2,79	84	60	52	Stand alone	No
	3:25	2:40	2:38	77	C	0,08	0,81	N/A	N/A	84	59,5	55	Stand alone	No
	3:25	2:40	2:38	79	C	0,08	0,81	N/A	N/A	84	59,5	55	Stand alone	No
	3:20	2:14	2:16	74	B	0,08	0,81	N/A	N/A	84	59,5	55	Stand alone	No
	3:20	2:14	2:16	79	C	0,09	0,36	N/A	2,80	84	59,5	55	Stand alone	No

Legend:  
a\* -> Nominal capacity  
b\* -> Half load  
c\* -> Quarter load

### Where is the Type?

It is possible to extrapolate the type starting from the first 8 digits of the serial code and excluding the final 0. **The serial code** is printed on the label visible on the upper side of the door when it is opened and/or on the backside of the washing machine.

### Example of label



## **TYPE - MODEL ASSOCIATIVE TABLE**

The various association of machine type-model-QR is only for EU market and clients. Hence, it is not reported in these section. The association is requested by the European Product Database for Energy Labelling (EPREL) directive.

Where necessary an supplementary sheet will be added.











<b>Program sequence</b>			
<b>Wash programme</b>	<b>Rinse</b>	<b>Spin</b>	
	<b>Number of rinse (The last rinse takes softener)</b>	<b>Intermediate</b>	<b>Final</b>
Cotton cold	2 + 1*	✓	✓
Cotton 20°C	2 + 1*	✓	✓
Cotton 40°C	2 + 1*	✓	✓
Cotton pre-wash 60 °C	2 + 1*	✓	✓
Cotton 90°C	2 + 1*	✓	✓
Rapid 30°C	1 + 1*	✓	✓
Rinse	1 + 1*	✓	✓
Drain/Spin	-	-	✓
Delicate 30°C	3 + 1*	-	✓
Wool 40°C	3 + 1*	-	✓
Synthetic cold	2 + 1*	✓	✓
Synthetic 40°C	2 + 1*	✓	✓
Synthetic 60°C	2 + 1*	✓	✓
Intensive 40°C	2 + 1*	✓	✓
Eco 40-60	2 + 1*	✓	✓


















\* *Extra rinse is selectable.*

# LAUNDRY SYMBOLS FOR WASHING MACHINE

The number inside the basket indicates the maximum temperature at which laundry can be washed.

Icon	Description	Icon	Description
	Normal wash max 90° - 95° C		Delicate wash max 60° C
	Normal wash max 60° C		Delicate wash max 40° C
	Normal wash max 40° C		Delicate wash max 30° C
	Normal wash max 30° C		Do not spin

# LAUNDRY SYMBOLS NOT FOR MACHINE WASHING

NOT IN WASHING MACHINE	IRONING	BLEACHING	DRYING
 Dry-cleaning with hydrocarbon	 about 200°C	 Bleaching allowed	 Delicate dry No heat
 Dry-cleaning with perchloroethylene	 about 150°C	 Only use oxygen bleach	 Delicate dry Low heat
 Dry-cleaning with all solvents	 about 110° C	 Do not bleach	 Delicate dry Medium heat
 Do not dry clean Do not dry clean	 Do not iron		 Low heat dry
	 No steam added to iron		 Do not tumble dry

## SCelta DEI DETERSIVI PER I PROGRAMMI

Programmes	Universal powdered detergent <sup>1</sup>	Liquid detergent	Liquid coloured detergent	Delicate in wool	Special	Temperature (°C)
Cotton cold	◆	◆	◆	◇	◇	0 - 90
Cotton 20°C	◆	◆	◆	◇	◇	40 - 60
Cotone 40°C	◆	◆	◆	◇	◇	0 - 60
Cotton prewash 60 °C	◆	◆	◆	◇	◇	0 - 30
Cotton 90°C	◆	◆	◆	◇	◇	0 - 40
Rapid 30°C	◇	◇	◇	◆	◆	0 - 30
Delicate 30°C	◇	◇	◇	◆	◆	0 - 40
Wool 40°C	◇	◇	◇	◆	◆	0 - 40
Synthetic cold	◆	◆	◆	◇	◇	Cold
Synthetic 40°C	◆	◆	◆	◇	◇	0 - 40
Synthetic 60°C	◆	◆	◆	◇	◇	0 - 60
Intensive 40°C	◆	◆	◆	◇	◇	0 - 40
Eco 40-60	◆	◆	◆	◇	◇	40-60

<sup>1</sup>At temperatures above 60°C, the use of powder detergent is recommended.

◆ = Recommended

◇ = Non recommended

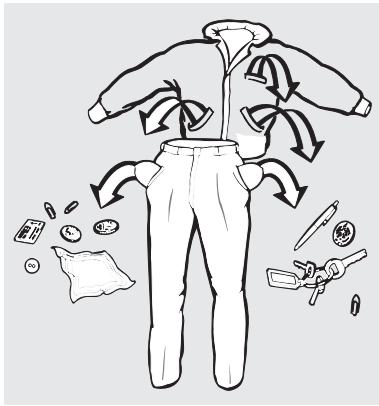
EN

# INSTRUCTIONS AND WARNINGS

## WASHING INSTRUCTIONS

- The appliance shall not be used by children or vulnerable persons without appropriate supervision.
- Children shall not be allowed to play with the appliance.
- For each garment, follow the washing instructions written on the clothing labels
- Make sure there are no coins, pins etc. into the pockets of the garments to be washed.

Figure 10



- Do not use gasoline, alcohol, trichlorethylene etc. on garments destined to be washed into the appliance.
- It is advisable to put small size pieces of laundry like socks, belts etc. into a mesh laundry bag before washing them; thus preventing them from getting caught and snag into the drum.
- Use the softener within the maximum recommended dose, since an excessive quantity may damage the garments.
- When the appliance is switched off, let the door half-opened, thus better preserving the gasket and avoiding musty odours.
- Before opening the door, always make sure that the water has been drained.
- Always turn off the water tap at the end of every washing cycle.
- Unplug the appliance if it is not used for long periods of time.

## LAUNDRY SELECTION

To ensure you are getting the best from your washing machine, clothing shall belong to one of the following types:

- White clothes
- Coloured
- Synthetics
- Delicates
- Wool

More specifically, it is important to consider that:

- White clothes will lose their “whiteness” if washed together with coloured clothes;
- New coloured clothes may stain the first washing. Therefore it is advisable to always wash them separately.

**Moreover, it is important to follow the washing instructions of the fabric labels and make sure that there are no metallic objects (such as clips, needles, screws, coins, curtain hooks etc.) in the laundry.**

Before washing, it may be needed to previously remove stains from particularly dirty clothing with a special detergent.

**Carpets, damaged clothes, hair, threads, dirty substances in general may clog up the drainage system.**

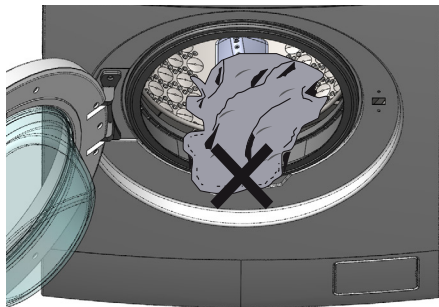
## LOADING LAUNDRY

To get the best washing results, it is necessary to place the laundry in the drum, one item at a time thus preventing it from knotting and twisting. Efficiency results are strongly affected by quantity and by the way garments are loaded into the appliance, An excessive load or lower than half the rated load capacity may undermine the reliability of the washing machine and it makes the appliance more noisy.

**In case of excessive load or lower than half the rated load capacity, it is recommended to reduce to a minimum the spin speed in order to avoid strong vibrations during the spinning cycle.**

**Before closing the door, make sure that no garment has been left on the edge of the gasket. This is to prevent any damage to the gasket. Please close the door with a slight push.**

Figure 11



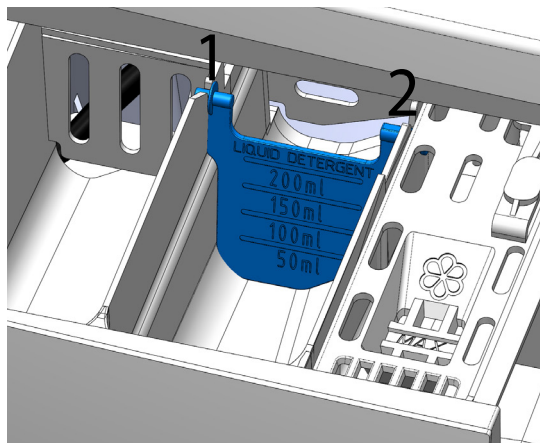
## DETERGENT DOSAGE

For each washing cycle, the correct amount of detergent has to be decided depending on the soil intensity of the laundry, as well as considering the load size and water hardness. Anyway, for each washing cycle, both detergent and softener have to be put before starting to wash.

## LIQUID DETERGENT BULKHEAD INSERT

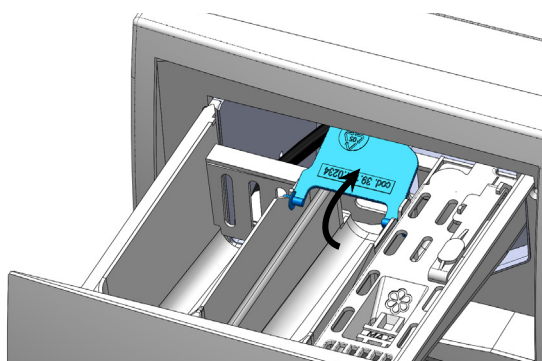
To use the liquid detergent, it is necessary to put the bulkhead insert provided in the kit with the appliance (figure 12):

Figure 12



Raise the bulkhead insert to use powder detergent (figure 13).

Figure 13



## STARTING WASHING PROGRAMME

1. To start the wash programme, turn the programme knob onto programme a desired programme.
2. Consider the opportunity to personalize the wash programme by regulating the temperature and/or spinning and the selection of one or more special options

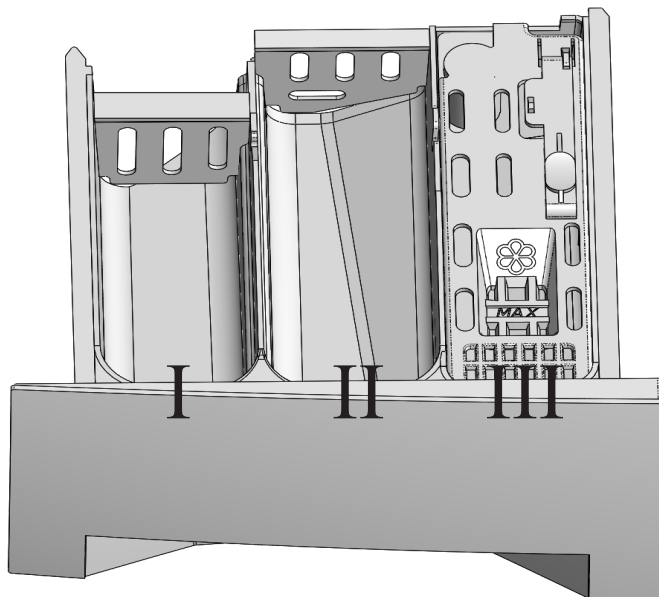
## STARTING WASHING CYCLE

After achieving all above mentioned operations, it is possible to start washing pressing the Start/Pause button.

## PAUSE WASHING

It is possible to stop the washing cycle by pressing the button Start/Pause. This way, the appliance switches to pause mode. To turn off the machine in order to change programme, turn the knob n° 1 to the OFF position and then select the new programme. At the end of the washing cycle, the red light turns off and the door can be opened only after checking the water level thus avoiding water leakages.

## DETERGENT DRAWER



**I** - Detergent compartment to be used during pre-wash and soak cycle.

**II** - Detergent compartment for powder and liquid detergent for main wash.

**III** - Compartment for liquid additives (softener, starch).

**WARNING:** Do not exceed the indicated MAX level.

# MAINTENANCE

## CABINET

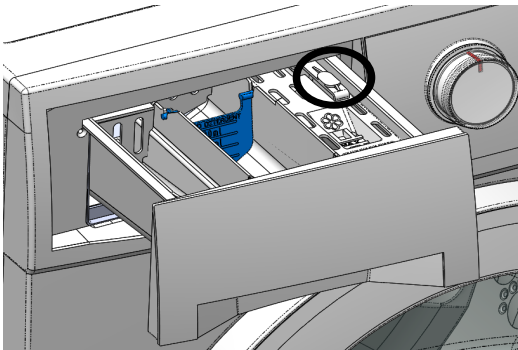
It is recommended to clean the cabinet of the appliance with lukewarm water thus preserving its original brightness for a long time.

During the cleaning of floors, absolutely avoid appliance coming into contact with detergents and/or corrosive cleaning agents to maintain the original shininess unchanged over time, avoiding areas of rust.

## DETERGENT DRAWER

To remove detergent deposits, it is recommended to pull out the detergent drawer by pressing the rounded area as shown in figure 14.

Figure 14



## CLEANING DETERGENT DRAWER

Once pulled the drawer out, remove the steam absorber divider as shown in the picture below.

Figure 15

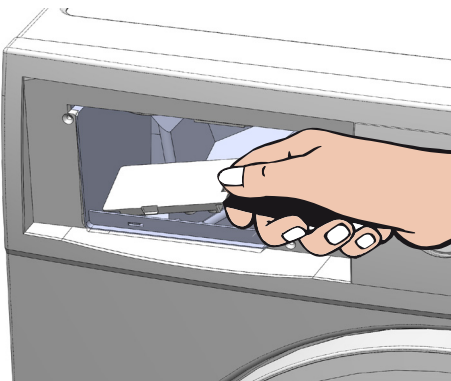
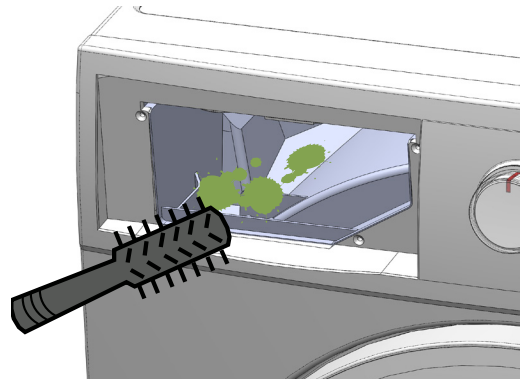


Figure 16



In case the draining hole of the drawer is obstructed by detergent deposits or foreign objects, it is recommended to remove the obstacle making sure not to push it to the bottom because it may clog up the internal circuit. We remind you that the detergent can be easily removed with hot water.

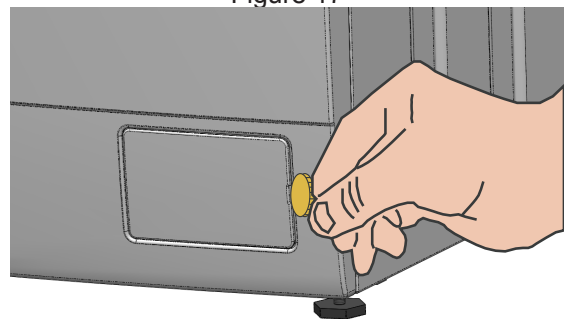
## DRAIN PUMP FILTER CLEANING

It is recommended to periodically clean the drain pump filter. To clean the filter, follow instructions below:

- Drain out the remaining water by selecting the "Drain" programme;
- Turn off the washing machine;
- Get a coin.

Insert the coin into the slot on the side in order to open the cover

Figure 17

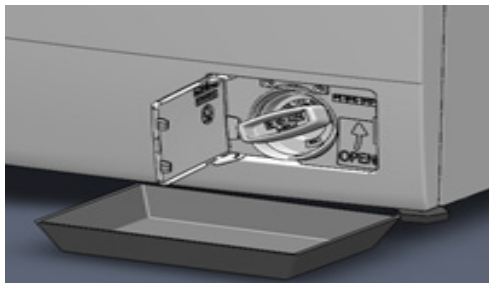


N.B If the drain circuit is clogged, there could be consistent quantity of water in the appliance (max. 25l).

## EMPTYING PROCEDURE

- 1) Place a tray between the cabinet and the end of the filter.

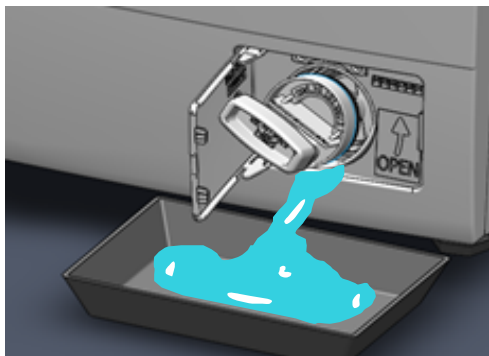
Figure 18



**Warning!** After a wash cycle with high temperature, wait until it is cooled down. Danger of burning.

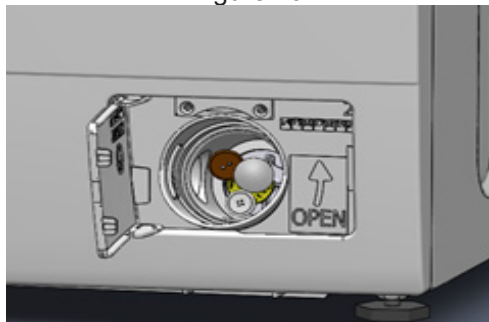
- 2) Loosen the filter using the appropriate holder in order to let the water flow.

Figure 19



When there is no more water coming out, unscrew the filter completely and clean it carefully. Remove any foreign objects from the filter.

Figure 20



Reinsert the drain filter and tighten it firmly until it locks.

**Warning!** If you do not reinsert the filter or you do not screw it until it is blocked, the water will come out of the machine.

## CLEANING OF ELECTRO-VALVE AND WATER SUPPLY HOSE FILTERS

To clean the filters follow the instructions below:

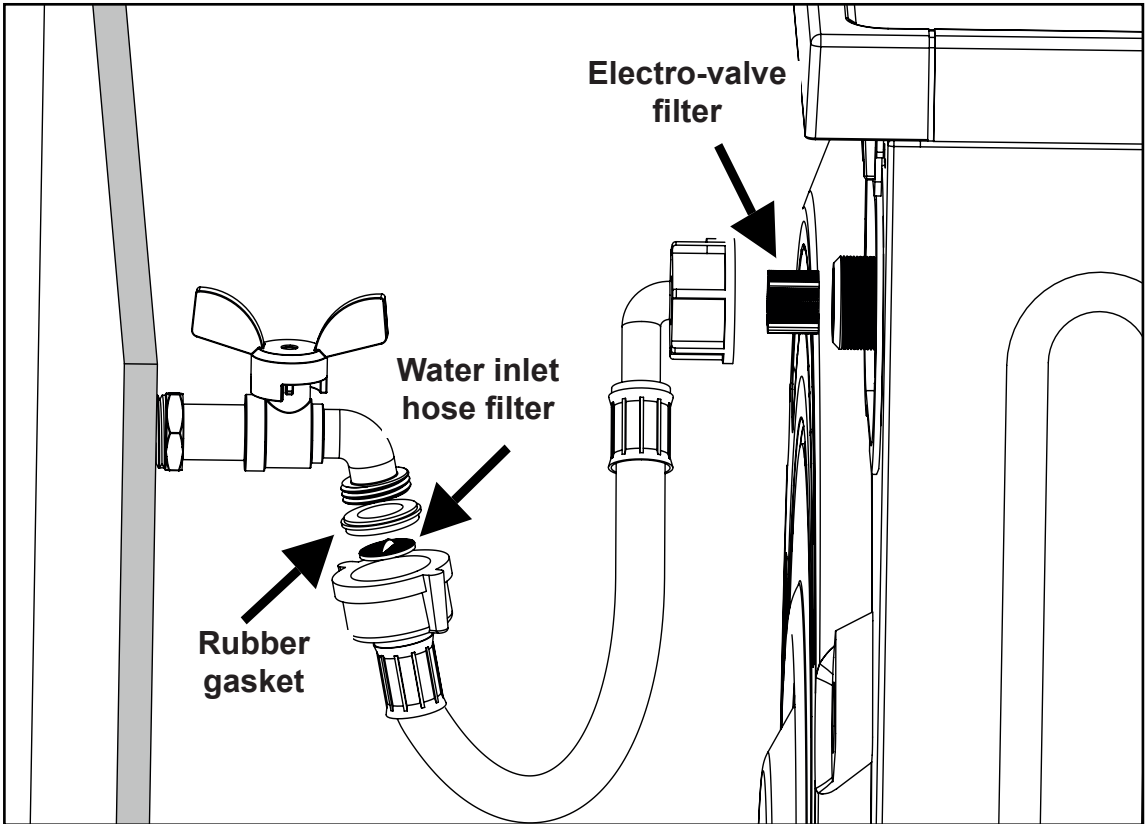
- Turn off the washing machine and disconnect the power cable.
- Close the water and disconnect the water supply inlet hose from the water tap and from the washing machine.
- Get pair of tweezers and a tooth brush.
- Remove the filters from their place (figure 21)
- Clean the filters with running water making use of the tooth brush.

## WATER LOADING TEST

1. Get a stopwatch;
2. Turn the programme knob to drain and let it run for about two minutes;
3. Turn the programme knob to cotton programme simultaneously start the programme and the stopwatch;
4. From the moment the washing machine drum starts turning, make sure the stopwatch does not exceed 80-90 seconds;
5. If that value exceeds, it is necessary to ensure the right grid pressure and check that the water supply hose filter and/or solenoid valve hose filter are not obstructed.

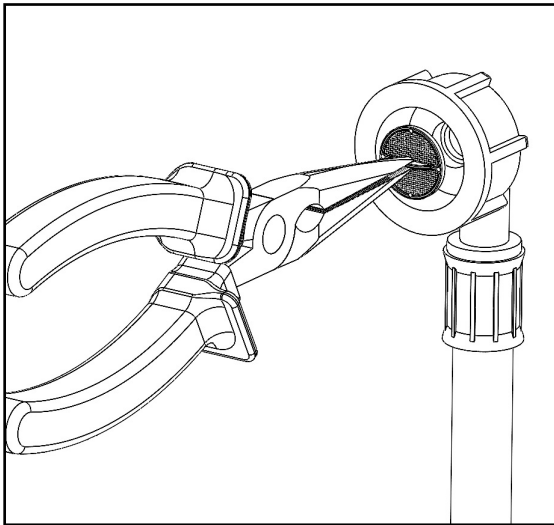


Figure 21

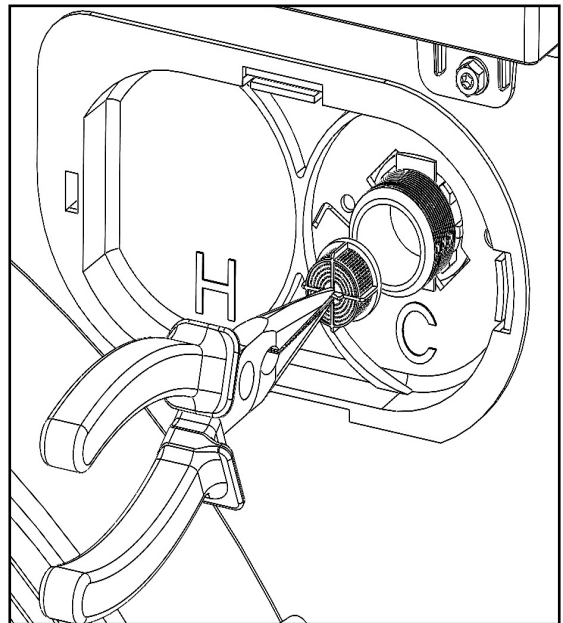


EN

Extraction water inlet hose filter\*

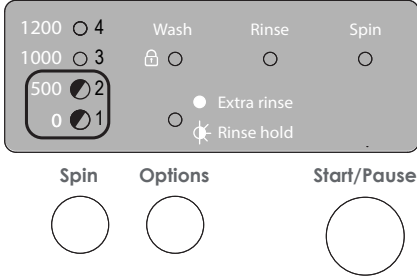
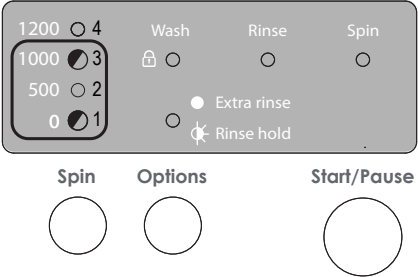
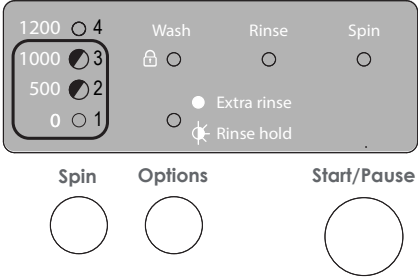
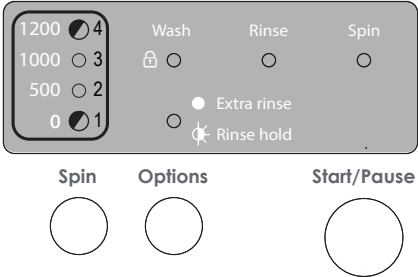


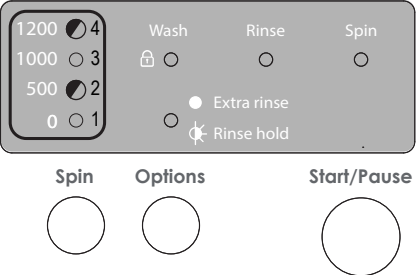
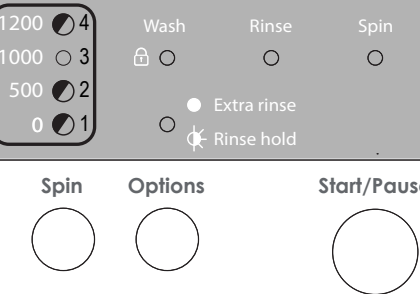
Extraction water valve filter



\*Before extracting the filter from the water inlet hose, remove the gasket indicated in figure 21.

# POSSIBLE REMEDIES

Problem	Diagnosis	Possible Solution
<p>THE WASHING MACHINE DOES NOT STAR</p>		<ul style="list-style-type: none"> <li>• Check whether the plug is properly inserted into the power socket.</li> <li>• Check whether there is power at the socket.</li> <li>• Verify the selector knob is not positioned on OFF.</li> </ul>
<p>THE WASHING MACHINE DOES NOT START THE PROGRAMME (lights N. 1-2 flashing)</p>	 <p>The diagram shows a control panel with a dial on the left and three buttons on the right. The dial has four positions: 1200 (light 4), 1000 (light 3), 500 (light 2), and 0 (light 1). Lights 1 and 2 are shown as lit. The buttons are labeled 'Wash', 'Rinse', and 'Spin' at the top, and 'Spin', 'Options', and 'Start/Pause' at the bottom. There are also 'Extra rinse' and 'Rinse hold' options.</p>	<ul style="list-style-type: none"> <li>• Reopen the door and close it with a slight push.</li> </ul>
<p>THE WASHING MACHINE DOES NOT TAKE WATER (lights N. 1-3 flashing)</p>	 <p>The diagram shows a control panel similar to the previous one. In this case, lights 1, 2, and 3 are shown as lit.</p>	<ul style="list-style-type: none"> <li>• Start the drain program and wait about 2 minutes.</li> <li>• Start the cotton program and check if the water comes out of the detergent drawer (fig. 14) with normal flow. If not, check the following:             <ol style="list-style-type: none"> <li>1. Make sure that the tap is open and that there is water supply.</li> <li>2. Make sure the inlet hose is not bent.</li> <li>3. Make sure the water inlet hose and/or the valve filters are not blocked (fig. 21).</li> </ol> </li> </ul>
<p>THE WASHING MACHINE DOES NOT HEAT (lights N. 2-3 flashing)</p>	 <p>The diagram shows a control panel similar to the previous ones. In this case, lights 2 and 3 are shown as lit.</p>	<ul style="list-style-type: none"> <li>• Turn off the washing machine and restart the wash programme.</li> </ul>
<p>THE WASHING MACHINE DOES NOT DRAIN (lights N. 1-4 flashing)</p>	 <p>The diagram shows a control panel similar to the previous ones. In this case, all four lights (1, 2, 3, and 4) are shown as lit.</p>	<ul style="list-style-type: none"> <li>• Remove the drain hose from the drainage line and make sure it directly drains into a container/sink, then select the drain programme.</li> <li>• Make sure the drain pump filter is not obstructed.</li> <li>• Make sure the drain hose is not squashed or kinked.</li> </ul>

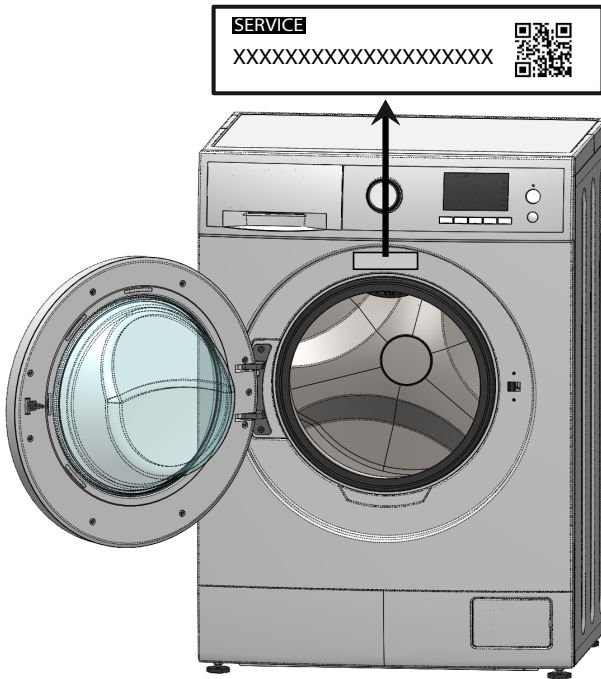
Problem	Diagnosis	Possible Solution
(Lights N. 2-4 flashing)		<ul style="list-style-type: none"> <li>• Switch off the washing machine and switch it back on.</li> </ul>
(Lights N. 1-2-4 flashing)		<ul style="list-style-type: none"> <li>• Switch off the washing machine and switch it back on.</li> </ul>
The door does not open	<ul style="list-style-type: none"> <li>• Make sure the red light is off</li> <li>• Make sure the appliance is not in soak mode or rinse hold special option.</li> <li>• Press on the door from the closing side or give a slight push while trying to open at the same time.</li> </ul>	
There is water on the floor	<ul style="list-style-type: none"> <li>• Make sure the water supply hose and the drain hose are not damaged and that there are no water leakages.</li> <li>• Make sure that there is no foam/ water coming out from the detergent drawer.</li> <li>• Reduce the detergent dose.</li> </ul>	
The washing machine take in water continuously even when it is off	<ul style="list-style-type: none"> <li>• <b>Turn off the water tap at the end of every wash cycle.</b></li> <li>• Reduce the water pressure or check the autoclave.</li> </ul>	

# SERVICE APRÈS-VENTE

## REPAIR

Many problems can be solved independently by the user using the information on the faults reported in these instructions or available on our website [www.sangiorgioelettrodomestici.it](http://www.sangiorgioelettrodomestici.it).

If this is not possible, please contact our customer service. We always find an adequate solution and try to avoid unnecessary visits by service technicians.



It is ensure that the appliance is repaired only with original spare parts and by specially trained customer service personnel, both during the warranty coverage and upon expiry of the same. For safety reasons, only adequately specialized and trained personnel can carry out repairs on the appliance. The warranty is void in the event of interventions or repairs are carried out by persons not authorized by the producer or in the event that the appliance is equipped with non-original spare parts, supplementary parts and accessories due to which a defect arises.

The original spare parts relevant for operation according to the Ecodesign regulation are available from our customer service department for a period of at least 10 years starting from the day of marketing of the appliance within the European community.

If any repairs are required, contact an authorised after sales service calling the number indicated. Always specify the model of the appliance and its **serial number** as reported on the rating plate on the cabinet visible on the upper side of the door when it is opened and/or on the back side of the washing machine.

# WARRANTY CERTIFICATE

## 1. Terms and Conditions of the Conventional Warranty

This conventional warranty is to be considered additional and not replacing any other right of the customer, being understood that customer is exclusively the physical person beyond any managerial or professional activity, who uses the household appliance for domestic/private use - ex Legislative Decree 6 September 2005, n. 206.

The conventional warranty has to be considered as a guarantee to free replacement or repair of parts of the appliance that show defects of conformity within 24 months of the date of purchase (12 months if purchased through commercial invoice and not fiscal receipt).

The conventional warranty is valid only on Italian territory including the Republic of San Marino and Vatican City and may be proved by a document issued by the retailer or other documentary proof (ie. fiscal receipt, invoice or document of delivery) reporting the name of the seller, date of delivery of the household appliance and, identification details of the latter (type of model).

## 2. Validity of the warranty

This warranty has full validity during the above mentioned period if:

The user claims the conformity defect within two months of its discovery; All operations such as installing, connecting to the domestic system and functioning of the appliance shall be executed following the use and maintenance instructions on the user manual carefully; All operations such as use, maintenance and daily care of the washing machine shall be executed in accordance with the prescriptions and instructions reported in this user guide.

Make sure any repair intervention is made exclusively by technicians belonging to After-Sale Service Centers authorized by the Manufacturer and using original spare parts only.

## 3. Intervention with warranty

During the validity period of this Warranty (24 months after the date of purchase), in case the authorized after-sale service has acknowledged a lack of conformity due to manufacturing defects, the manufacturer commits itself to repair/replace the household appliance without costs for the customer.

The replacement of the appliance can take place only in case it is objectively possible and not disproportionate compared to repair.

According to art. 130 of the Consumer Code, the requested solution is "disproportionate" if it imposes costs on the seller which, in comparison to other remedies, are unreasonable, taking into account the value the goods would have if there were no lack of conformity, the significance of the lack of conformity, and whether the alternative remedy could be completed without significant inconvenience to the consumer.

All requests regarding replacement or repair of the household appliance have to be evaluated by the After-Sale Service whose opinion is binding and indisputable. Any repair/replacement of components or appliance do not extend the duration of this warranty which shall continue, in any case, until its expiry date as provided for in previous clause 1.

As from more than 6 months after the date of delivery of the product to the consumer, period of time during which the defect of conformity can be considered to be already existed on that date (art. 132 of Consumer Code), and only when the malfunction does not depend on a vice of conformity, SANGIORGIO IT Wash may ask the reimbursement of the cost to the consumer – always reasonable and previously indicated – incurred for the verification of the malfunctioning.

## 4. Exclusion clauses

This Conventional Manufacturer Warranty does not cover interventions and/or repairs and/or spare parts which shall result defective for the following reasons:

- a) Damages caused by transport or handling of the household appliance, or damages arising from circumstances and/or events caused by force majeure, which, in any case, cannot be connected to manufacturing defects of the household appliance.

- b) Operations of installation and assembly (for example: fault connection/power supply; lack of the protective earth connection; inadequate water supply/drain; removal of the fixing brackets on the tub; any possible regulation such as the floor level under the household appliance).
- c) An incorrect, improper or incomplete installation, lack of capacity to use by the Consumer or Installer, if there is not enough place to operate around the product (at least 3 cm on the upper side, 8 cm on both sides and 8 cm on the rear) or excessively high/low temperature of the environment (in case the household appliance has been placed on balconies, terraces, roofs, in direct contact with atmospheric agents: sun, rain, cold and lightning).
- d) Interventions where the claimed defect was not found, due to a misleading impression of the consumer (for example: noise, vibration or hooping, excessive foam, no spinning, it does not wash properly, it tears the garments, etc.).
- e) Intervention on products placed in improper positions or in dangerous areas (roofs, etc.) which may not guarantee the operator safety as established by Law 626-94 concerning safety at work.
- f) Damages caused by weathering agents (lightning, earthquakes, fires, floods, etc.)
- g) If the serial number results to be removed, erased or modified.
- h) Failure to comply with the instructions for use and maintenance as reported in the correspondent user manual (drain filter and water supply, removal of foreign objects, excessive load, etc.).
- i) Maintenance, repair, modifications or tampering operations (removal of the top, back plate, etc.) executed by personnel not authorized by the manufacturer and/or use of non original spare parts.
- j) Lack of fiscal documents or when they appear to be counterfeited or not related to the product.
- k) Negligence and carelessness and/or improper use of the appliance (not for domestic use and differently in any way from what established by the manufacturer).
- l) For any other external circumstance not related to manufacturing defects of the household appliance.

This warranty only covers defects of conformity of the product and therefore it does not include regular check and maintenance operations. Consequently, in case there has been an intervention at the request of the consumer made by a technician of the after-sale service centre, for reasons related to above mentioned situations, the costs for the intervention and any spare part needed shall be totally charged to the consumer.

### **5. Limitations to the Manufacturer Liability**

The manufacturer cannot be held liable for damages that could affect, directly or indirectly, persons or goods resulting from failure to comply with instructions included into the correspondent user manual, in particular those regarding the installation, use and maintenance of the household appliance.

This Warranty is the unique Warranty given by the manufacturer. No third party is authorised to modify its terms or to give other oral or written warranties.

### **6. Expiration of the Warranty**

Once elapsed the warranty period established by this Manufacturer Conventional Warranty as indicated in clause 1, any repair and/or replacement intervention shall be at the expenses of the consumer, in line with the current tariffs of the network of authorized After-Sale Service centres.

**\*\* Failure to comply with the instructions on use not only is extremely dangerous for your own safety but it will result in an exclusion of all assistance provided this warranty.**

**Due to the continuous technological evolution of the products, the data contained in this manual may undergo slight variations without the manufacturer's prior notice.**

**SANGIORGIO**

Zona Industriale ASI di Acerra  
80011 Acerra (NA)

[www.sangiorgioelettronidomestici.it](http://www.sangiorgioelettronidomestici.it)  
[info@sangiorgioelettronidomestici.it](mailto:info@sangiorgioelettronidomestici.it)

April 2021

396010718\*\*